

International
IR Rectifier

MUR2020CT
 MURB2020CT
 MURB2020CT-1

Ultrafast Rectifier

Features

- Ultrafast Recovery Time
- Low Forward Voltage Drop
- Low Leakage Current
- 175°C Operating Junction Temperature

$$t_{rr} = 25\text{ns}$$

$$I_{F(AV)} = 20\text{Amp}$$

$$V_R = 200\text{V}$$

Description/ Applications

International Rectifier's MUR.. series are the state of the art Ultra fast recovery rectifiers specifically designed with optimized performance of forward voltage drop and ultra fast recovery time.

The planar structure and the platinum doped life time control, guarantee the best overall performance, ruggedness and reliability characteristics.

These devices are intended for use in the output rectification stage of SMPS, UPS, DC-DC converters as well as free-wheeling diode in low voltage inverters and chopper motor drives.

Their extremely optimized stored charge and low recovery current minimize the switching losses and reduce over dissipation in the switching element and snubbers.

Absolute Maximum Ratings

Parameters	Max	Units
V_{RRM} Peak Repetitive Peak Reverse Voltage	200	V
$I_{F(AV)}$ Average Rectified Forward Current	10	A
Total Device, (Rated V_R), $T_C = 145^\circ\text{C}$	20	
I_{FSM} Non Repetitive Peak Surge Current	100	Per Leg
I_{FM} Peak Repetitive Forward Current	20	
(Rated V_R , Square wave, 20 KHz), $T_C = 145^\circ\text{C}$		
T_J, T_{STG} Operating Junction and Storage Temperatures	-65 to 175	$^\circ\text{C}$

Case Styles		
<p>MUR2020CT</p>  <p>TO-220AB</p>	<p>MURB2020CT</p>  <p>D²PAK</p>	<p>MURB2020CT-1</p>  <p>TO-262</p>

Electrical Characteristics @ T_J = 25°C (unless otherwise specified)

Parameters	Min	Typ	Max	Units	Test Conditions
V _{BR} , V _r Breakdown Voltage, Blocking Voltage	200	-	-	V	I _R = 100μA
V _F Forward Voltage	-	-	0.85	V	I _F = 8A, T _J = 125°C
	-	-	1.15	V	I _F = 16A, T _J = 25°C
	-	-	1.05	V	I _F = 16A, T _J = 125°C
I _R Reverse Leakage Current	-	-	15	μA	V _R = V _R Rated
	-	-	250	μA	T _J = 150°C, V _R = V _R Rated
C _T Junction Capacitance	-	55	-	pF	V _R = 200V
L _S Series Inductance	-	8.0	-	nH	Measured lead to lead 5mm from package body

Dynamic Recovery Characteristics @ T_J = 25°C (unless otherwise specified)

Parameters	Min	Typ	Max	Units	Test Conditions	
t _{rr} Reverse Recovery Time	-	-	35	ns	I _F = 1.0A, di _F /dt = 50A/μs, V _R = 30V	
	-	-	25		I _F = 0.5A, I _R = 1.0A, I _{REC} = 0.25A	
	-	21	-	A	T _J = 25°C	
	-	35	-		T _J = 125°C	
I _{RRM} Peak Recovery Current	-	1.9	-	T _J = 25°C	I _F = 10A V _R = 160V di _F /dt = 200A/μs	
	-	4.8	-	T _J = 125°C		
Q _{rr} Reverse Recovery Charge	-	25	-	nC		T _J = 25°C
	-	78	-			T _J = 125°C

Thermal - Mechanical Characteristics

Parameters	Min	Typ	Max	Units
T _J Max. Junction Temperature Range	-	-	- 65 to 175	°C
T _{Stg} Max. Storage Temperature Range	-	-	- 65 to 175	
R _{thJC} Thermal Resistance, Junction to Case Per Leg	-	-	2.5	°C/W
R _{thJA} Thermal Resistance, Junction to Ambient Per Leg	-	-	50	
R _{thCS} ^① Thermal Resistance, Case to Heatsink	-	0.5	-	
Wt Weight	-	2.0	-	g
	-	0.07	-	(oz)
Mounting Torque	6.0	-	12	Kg-cm
	5.0	-	10	lbf.in

① Mounting Surface, Flat, Smooth and Greased

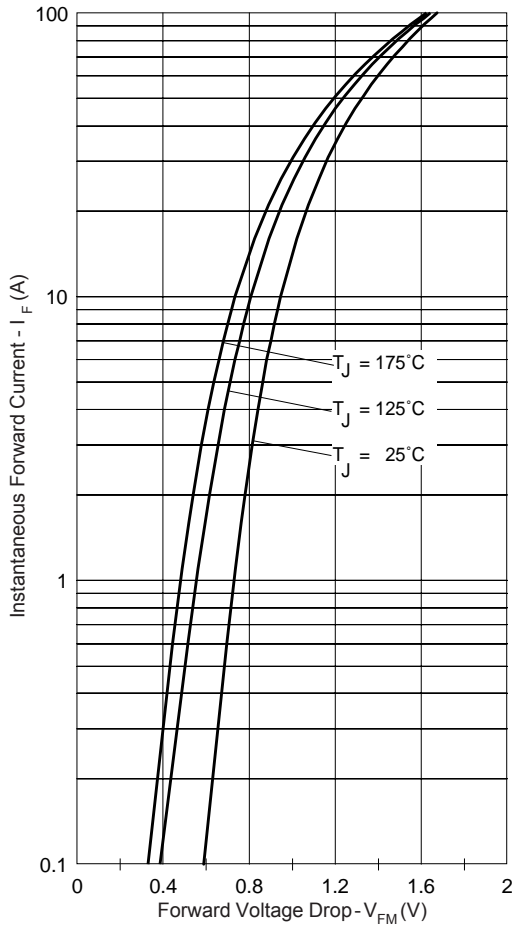

Fig. 1 - Typical Forward Voltage Drop Characteristics

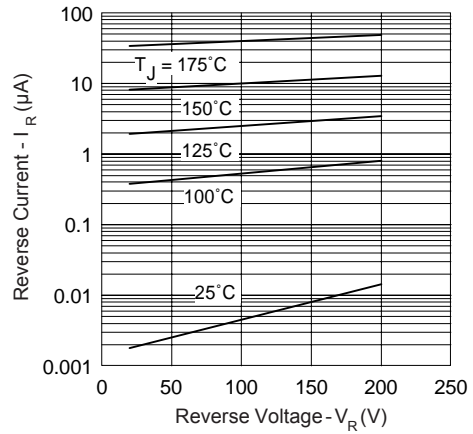

Fig. 2 - Typical Values Of Reverse Current Vs. Reverse Voltage

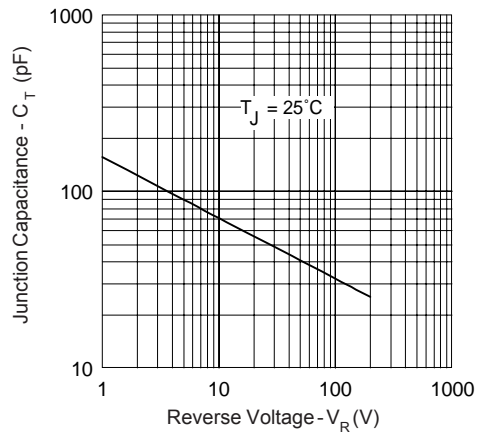

Fig. 3 - Typical Junction Capacitance Vs. Reverse Voltage

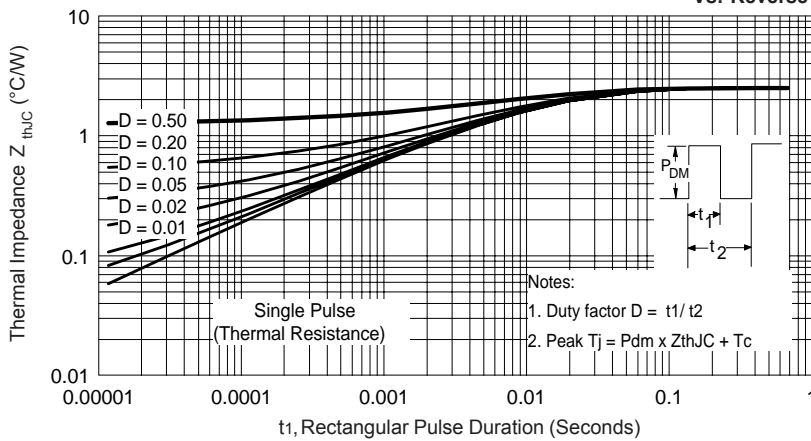

Fig. 4 - Max. Thermal Impedance Z_{thJC} Characteristics

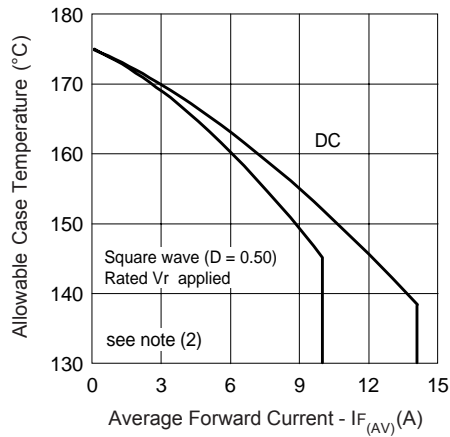

Fig. 5 - Max. Allowable Case Temperature Vs. Average Forward Current

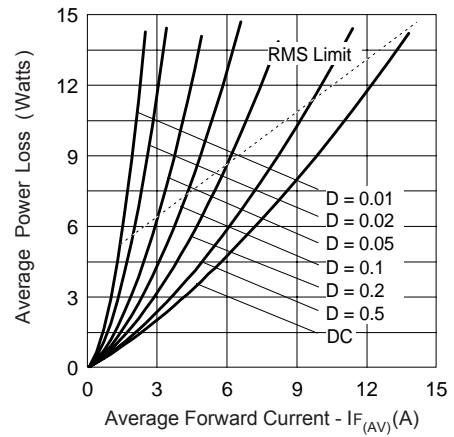

Fig. 6 - Forward Power Loss Characteristics

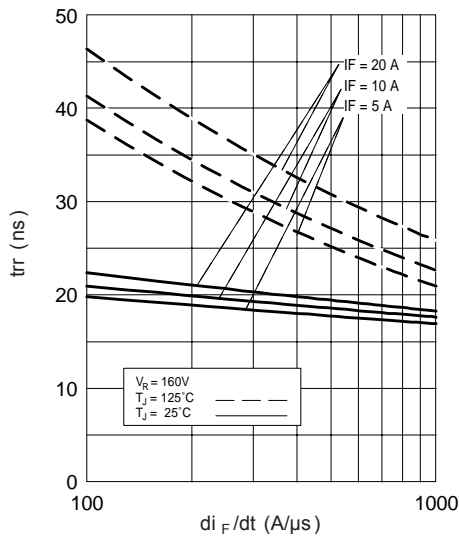

Fig. 7 - Typical Reverse Recovery vs. di_F/dt

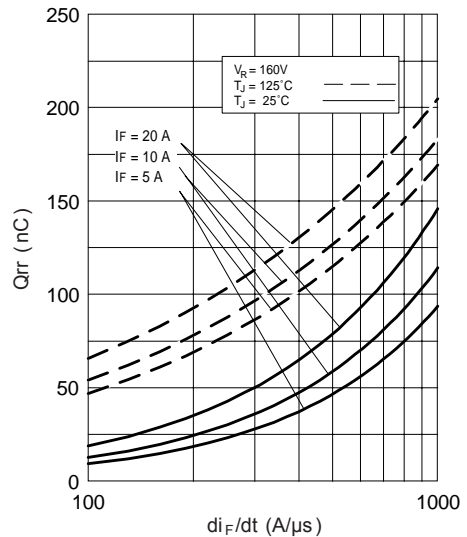

Fig. 8 - Typical Stored Charge vs. di_F/dt

(2) Formula used: $T_C = T_J - (P_d + P_{d_{REV}}) \times R_{thJC}$;
 $P_d = \text{Forward Power Loss} = I_{F(AV)} \times V_{FM} @ (I_{F(AV)} / D)$ (see Fig. 6);
 $P_{d_{REV}} = \text{Inverse Power Loss} = V_{R1} \times I_R (1 - D)$; $I_R @ V_{R1} = \text{rated } V_R$

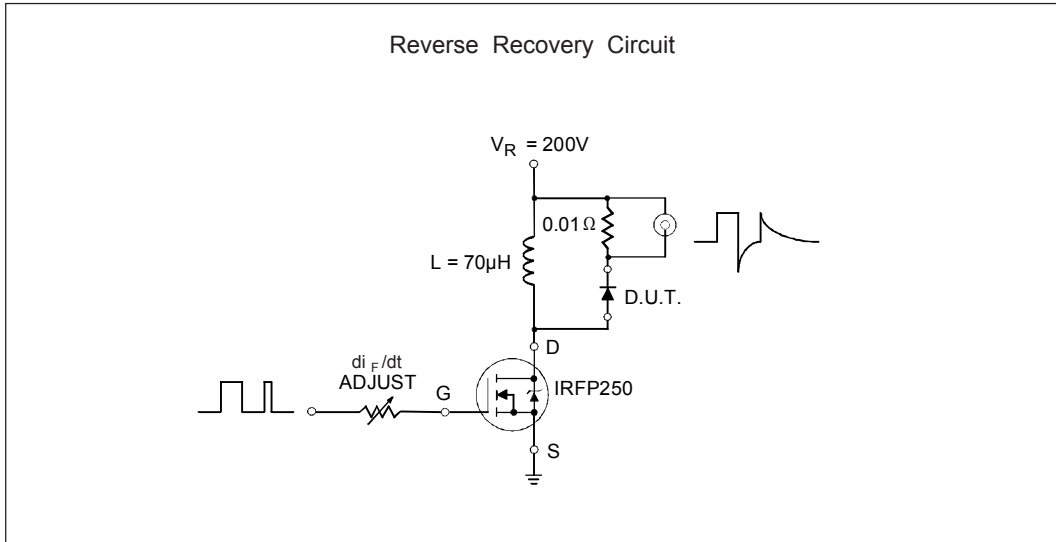

Fig. 9- Reverse Recovery Parameter Test Circuit

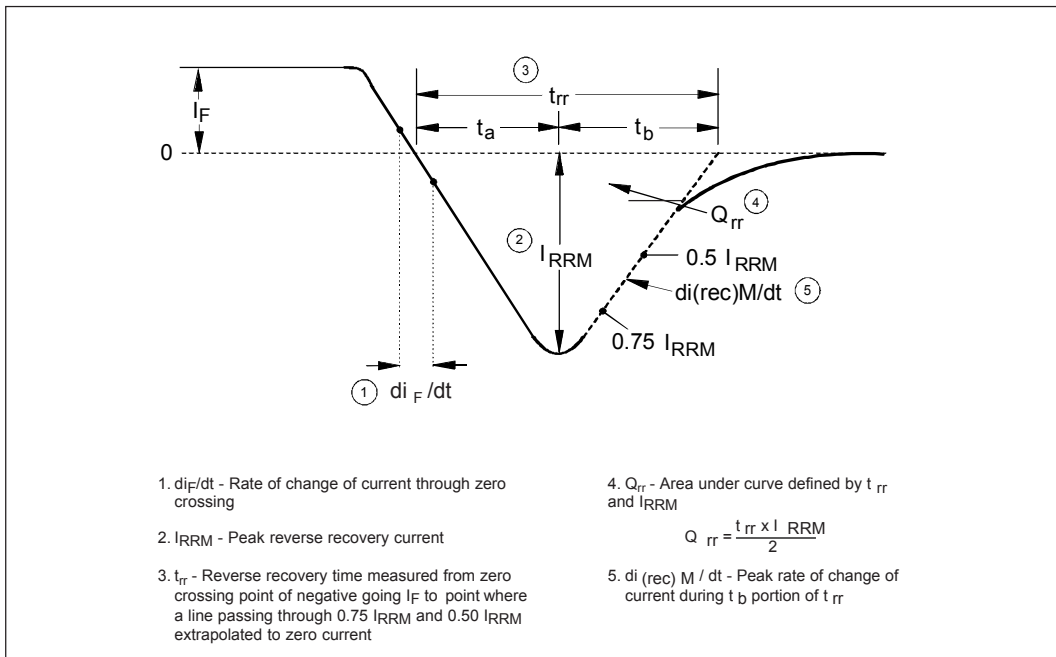
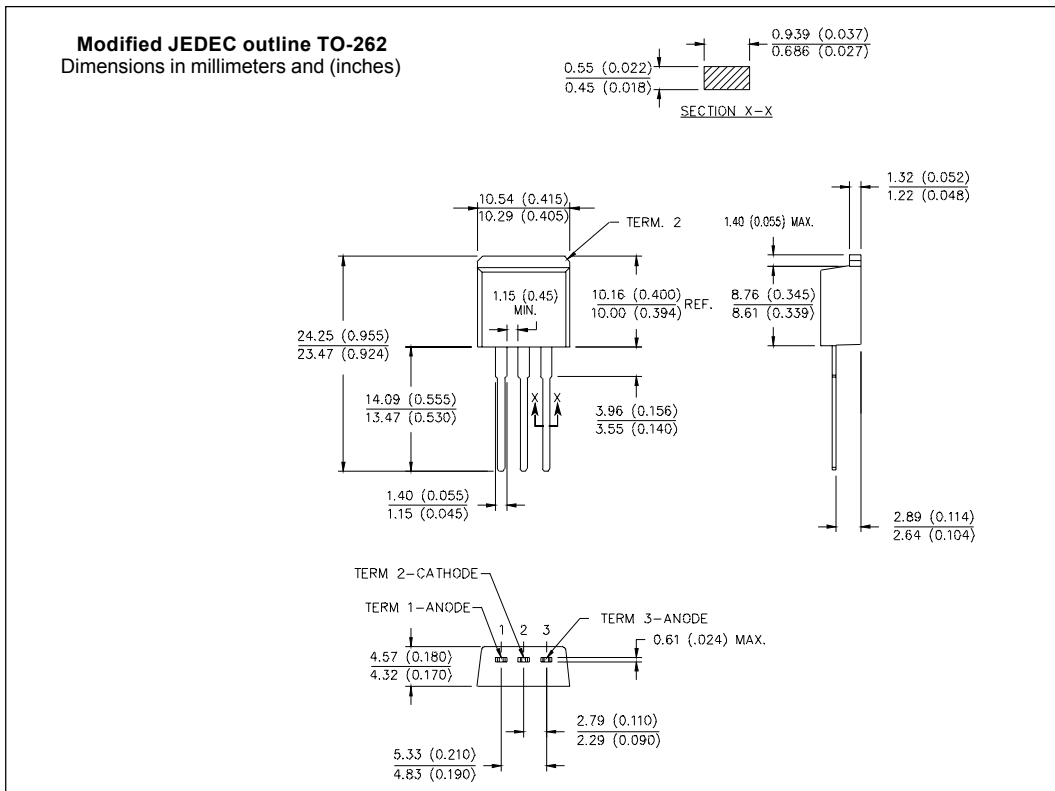
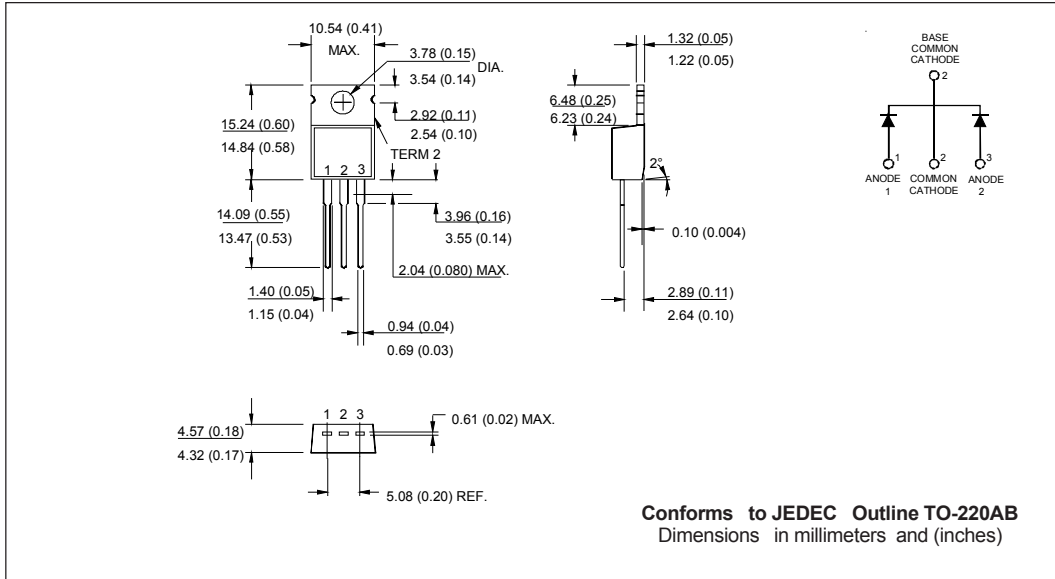
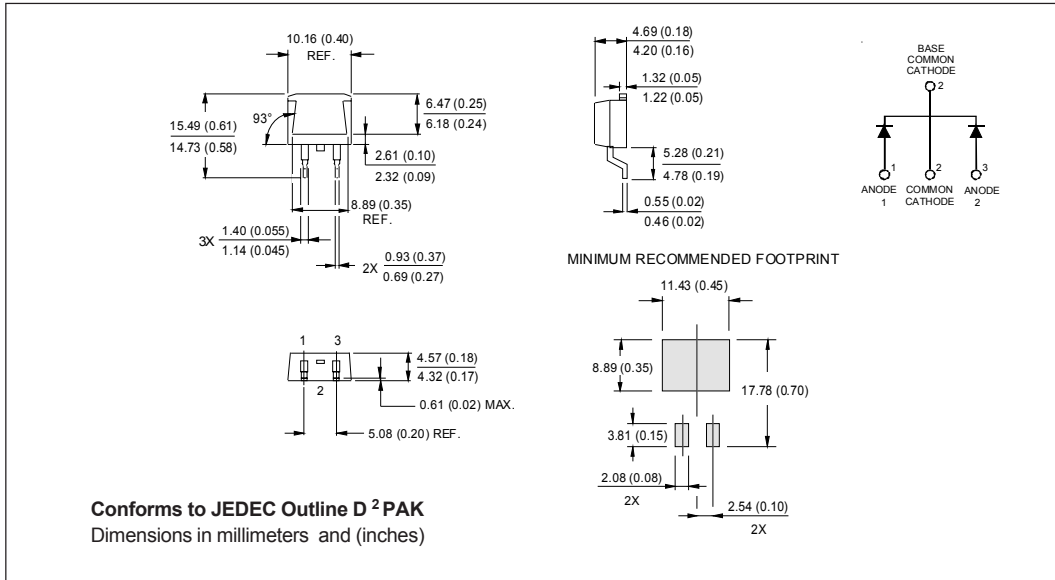

Fig. 10 - Reverse Recovery Waveform and Definitions

Outline Table



Outline Table



Ordering Information Table

Device Code					
MUR	B	20	20	CT	-1
①	②	③	④	⑤	⑥
1	- Ultrafast MUR Series				
2	- B = D ² Pak / TO-262 None = TO-220AB				
3	- Current Rating (20 = 20A)				
4	- Voltage Rating (20 = 200V)				
5	- CT = Center Tap (Dual) TO-220 /D ² PAK/ TO-262				
6	- "-1" = TO-262 Option				

```

MUR2020
*****
* SPICE Model Diode *
*****
.SUBCKT MUR2020 ANO CAT
D1 ANO 1 CAT
*Define diode model
.MODEL DMOD D (IS=1.04703N N=1.44364 BV=280 IBV=100P RS=7.57994M
+ CJO=218.618P VJ=700M M=399.212M EG=1.11 RL=17.4782G)

*****

.ENDS MUR2020

Thermal Model Subcircuit
.SUBCKT MUR2020 5 1

CTHERM1 5 4 3.93E+01
CTHERM2 4 3 2.67E+02
CTHERM3 3 2 5.20E+02
CTHERM4 2 1 1.66E+03

RTHERM1 5 4 1.12E+00
RTHERM2 4 3 1.04E+00
RTHERM1 3 2 1.57E-01
RTHERM1 2 1 1.89E-01

.ENDS MUR2020
    
```

Data and specifications subject to change without notice.
 This product has been designed and qualified for Industrial Level.
 Qualification Standards can be found on IR's Web site.